



Industrial PC

# PPC-J6412-156-C



PN: PPC-J6412-156-C

Content can change at anytime, check our website for latest information of this product.

[www.chipsee.com](http://www.chipsee.com)

# Contents

---

PPC-J6412-156-C	3
1. Product Overview	7
2. Ordering Options	8
2.1. Operating System	8
2.2. Optional Features	9
3. Hardware Features	10
4. Power Input	12
5. Touch Screen	13
6. Connectivity	14
6.1. RS232/485/GPIO Connectors	14
6.2. USB HOST Connectors	16
6.3. LAN Connectors	17
6.4. HDMI Connector	18
6.5. Audio	19
7. CMOS Button	20
8. Mounting Procedure	21
9. Mechanical Specifications	21
10. Disclaimer	22
11. Technical Support	22

# PPC-J6412-156-C

## Front View



# Rear View



# Side View 1



## Side View 2



## Product Overview

The PPC-J6412 series PPC-J6412-156-C is a rugged, high-quality NEMA 4X/IP65-compliant industrial panel PC. It features a 15.6" multi-point capacitive touch screen with a resolution of 1920 x 1080 pixels.

### Key Applications

- Human Machine Interface HMI
- Industrial Automation
- Process Control
- Smart Grid Management
- CNC Manufacturing
- Environmental Monitoring
- Machine Vision Inspection
- ATM, Kiosk, Infotainment...

The PPC-J6412-156-C Industrial Panel PC is powered by Intel® Celeron® J6412 quad-core CPU and equipped with a broad range of connectivity options, allowing it to meet highly demanding application requirements in harsh industrial or outdoor environments.

A specially designed magnesium-aluminum alloy housing with fins for increased heat dissipation serves as a passive cooler, eliminating the need for built-in fans. The fan-less design reduces noise, as well as the maintenance costs and efforts, increasing reliability at the same time.

#### Caution

Be careful when handling the product while it is operating: the back panel might become hot under heavy CPU load.

## Ordering Options

Most of the Chipsee products can be customized during the ordering process. The product will be shipped with the pre-installed factory defaults if no extra requirements are specified. The table in the [Hardware Features](#) section provides information about the default options bundled with the product.

 **Note**

You can order [PPC-J6412-156-C](#) from the official [Chipsee Store](#) or from your nearest distributor.

## Operating System

By default, PPC-J6412-156-C comes with Linux(Ubuntu 20.04) pre-installed. A different OS can be selected during the ordering process. In addition to Linux, PPC-J6412-156-C also supports Windows 7, Windows 10.



## Optional Features

The PPC-J6412-156-C Industrial Panel PC does not include WiFi/BT and/or 3G/4G/LTE/5G modules by default. The Wi-Fi/BT module is optional and can be selected during the ordering process.

A 3G/4G/LTE/5G module is not available at the Chipsee store for this product. However, it can be obtained from specialized third-party suppliers.

The 5G module only supports USB2.0 speed.

### **Warning**

Installation, repair, and maintenance tasks should be performed by trained personnel only.  
Chipsee does not bear any responsibility for damage caused by inadequate handling of the product.

## Hardware Features

The PPC-J6412-156-C Industrial Panel PC offers a broad range of performance and connectivity options for scalable integration, providing expandability to fit future requirements. Some of the key features are listed in the table below.

PPC-J6412-156-C	
<b>CPU</b>	Intel® Celeron® J6412, 2GHz, Quad-Core, 1.5M Cache, TDP=10W
<b>GPU</b>	Intel® HD integrated GPU, 512MB shared memory
<b>RAM</b>	Default 4GB, maximum 32GB, 1 x DDR4 3200 SO-DIMM
<b>Display</b>	15.6" LCD, resolution 1920 x 1080 px, brightness 500 cd/m <sup>2</sup>
<b>Storage</b>	Default mSATA 64GB SSD; 1 x SATA2.5 HDD 1T; 1 x M.2 2280 NVMe PCI-E 3.0 x 2 Slot
<b>Touch</b>	Multi-point capacitive touch screen
<b>Audio</b>	Realtek High Definition Audio Codec, MIC/Line-Out, Amplifier
<b>USB</b>	4 x USB 3.0 Type A HOST
<b>LAN</b>	2 x RJ45, 1Gbps (Realtek)
<b>UART</b>	Default 4 x RS232 (2 of 4 can be configured as RS485)
<b>GPIO</b>	8 x General Purpose I/O (GPIO) channels, ITE 8786E Chip
<b>3G/4G/LTE/5G</b>	Optional, module available from other manufacturers/stores
<b>WiFi/BT</b>	Optional, module available from the Chipsee store
<b>Expandability</b>	2 x Mini-PCIe (One for optional WiFi/BT/3G/4G/5G, one for mSATA)
<b>HDMI</b>	1 x HDMI out
<b>Power IN</b>	From 9V to 30V DC
<b>Power Consumption</b>	28W
<b>OS</b>	Ubuntu 20.04(default), Windows 7, Windows 10
<b>Operating Temp.</b>	From -20°C to +60°C (with SSD)
<b>Storage Temp.</b>	From -30°C to +80°C
<b>Humidity</b>	From 5% to 95% relative humidity (no condensation)
<b>Dimensions</b>	422 × 271 × 52.5mm
<b>EMC</b>	CE/FCC/ROHS/ISO-9001
<b>Mounting</b>	VESA 100mm, Panel mounting with fixtures, Wall, Desktop
<b>Weight</b>	4200g

Table 301 Key Features

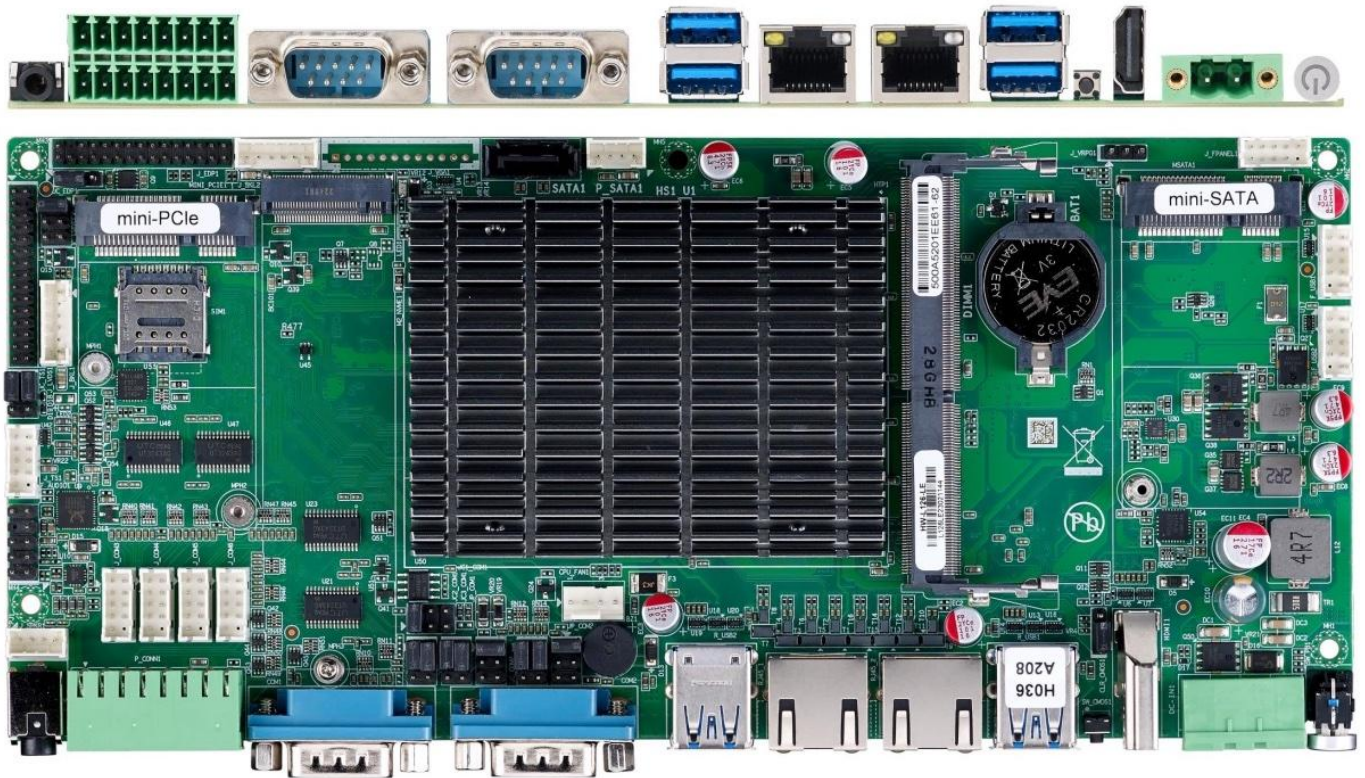

PCB of the product

## Power Input

The PPC-J6412-156-C Industrial Panel PC can be powered by a wide range of input voltages: from 9V to 30V DC. The power input connector is a 2-pin, 3.81 mm screw terminal. The polarity of the power connector is clearly labelled on the housing itself: the '+' sign is the positive, while the '-' sign is the negative power supply input.

The **POWER** button is located next to the power input connector and can be used to switch the power ON or OFF.

The power input section of PPC-J6412-156-C features a range of protection features, including over-current, over-voltage, power surge, and reverse polarity protection, allowing it to meet stringent industrial safety regulations.

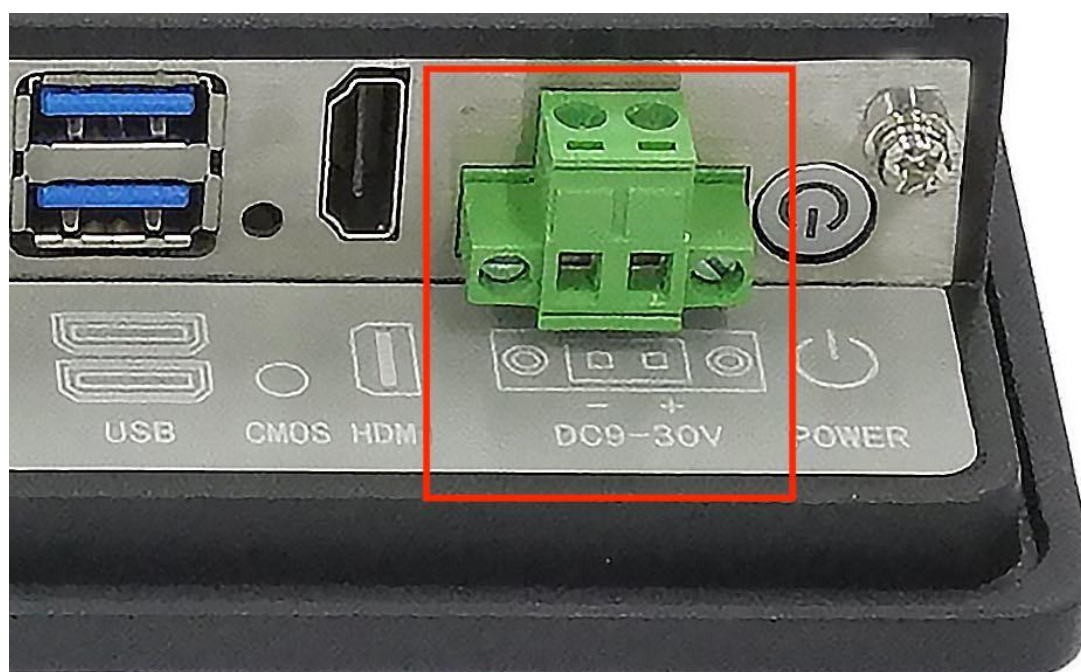

*Power Input*

### Note

If the product is used to control some key processes, it is highly recommended to use an Uninterruptible Power Supply (UPS) to prevent critical data loss.

## Touch Screen

PPC-J6412-156-C is equipped with a multi-point capacitive touch screen. Its multitouch detection capability enables implementation of some advanced GUI operations, such as two-finger zoom or rotation.

The capacitive touch screen can be operated by fingers, gloves with a special coating, or a conductive stylus.

**Size/Type:** 15.6" multi-point capacitive touch screen

**Touch screen structure:** G+F+F

**Surface Strength:** 7H

**Surface Hardness:** 50G steel ball 70cm impact drop 3 times not broken

**Service Life (MTBF):** 50 million touch events

**Light Transmittance:** > 92%

## Connectivity

There are many connectivity options available on the PPC-J6412-156-C industrial PC. It has 4 x USB Type A connectors configured as HOSTS, 1 x HDMI port, 2 x RJ45 connectors supporting Gigabit Ethernet (GbE), and up to 4 x RS232 connectors, of which two can be configured in the RS485 mode. There are also 8 x GPIO channels for various user-defined purposes.

### RS232/485/GPIO Connectors

The PPC-J6412-156-C Industrial Panel PC has 2 x 9-pin D-sub connectors and 1 x 16-pin 3.81mm connector with pluggable terminal block. Two 9-pin D-sub connectors labelled as **COM1** and **COM2** can be configured either as RS232 or RS485 communication interfaces.

The top row of terminals on the terminal block is labelled as **COM3/4**. These terminals are configured as two additional RS232 interfaces by default. The bottom row of terminals on the terminal block represents eight **GPIO** channels, labelled as **GPIO (0 ... 7)**.

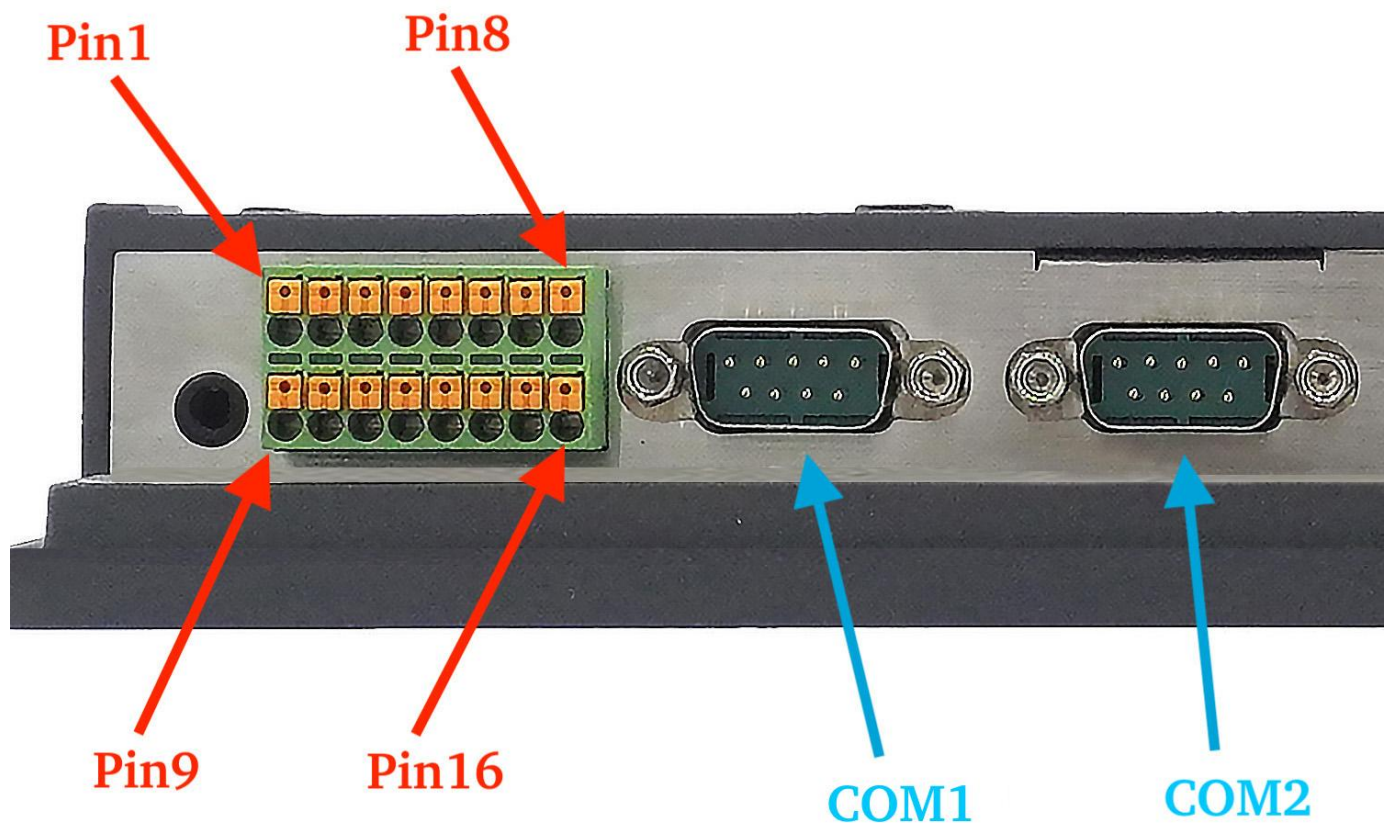

## GPIO, RS232, RS485

Pin	Definition
1	COM3-RXD
2	COM3-TXD
3	GND
4	COM4-RXD
5	COM4-TXD
6	+5V
7	PWR-
8	PWR+
9	SIO_GPI80(0xA07 Bit0)
10	SIO_GPI81(0xA07 Bit1)
11	SIO_GPI82(0xA07 Bit2)
12	SIO_GPI83(0xA07 Bit3)
13	SIO_GPO84(0xA07 Bit4)
14	SIO_GPO85(0xA07 Bit5)
15	SIO_GPO86(0xA07 Bit6)
16	SIO_GPO87(0xA07 Bit7)

Table 302 GPIO/COM3/COM4 Pin Definition

 **Note**

The default configuration of the PPC-J6412-156-C industrial PC is 4 x RS232 interfaces and 8 x GPIO channels. If you need different configuration, please contact Chipsee Technical Support at [support@chipsee.com](mailto:support@chipsee.com)

## USB HOST Connectors

PPC-J6412-156-C is equipped with 4 x USB 3.0 connectors. The data throughput of the USB 3.0 interface can reach up to 4.8 Gbps.

Although fully compatible with USB 2.0 devices, the USB 3.0 interface provides 10 times more data transfer bandwidth than USB 2.0, making it best suited for fast peripherals that can utilize its full potential.

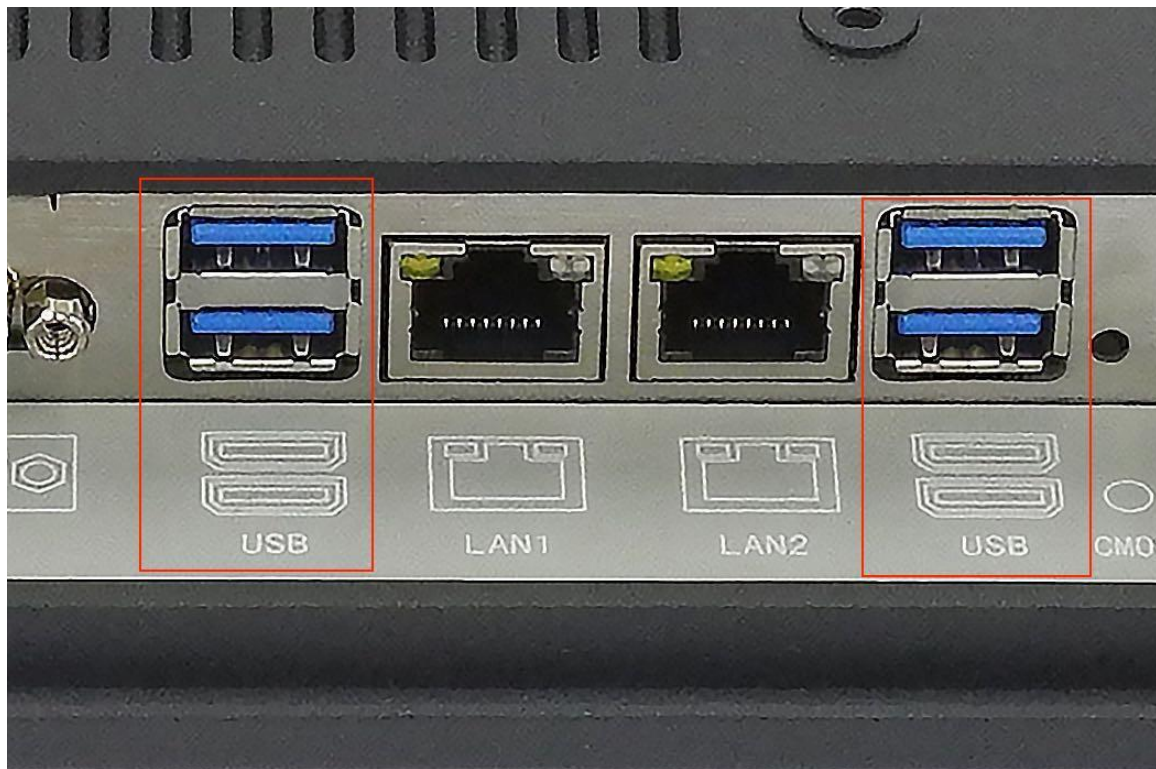

*4 x USB3.0 HOST Connectors*



## LAN Connectors

2 x **LAN (RJ45) connectors** provide Ethernet connectivity over standardized Ethernet cables. The integrated two-port Ethernet interface supports 10/100/1000BASE-T/TX specifications with automatic speed negotiation and Wake on LAN (WoL) feature. Power over Ethernet (PoE) is not supported.

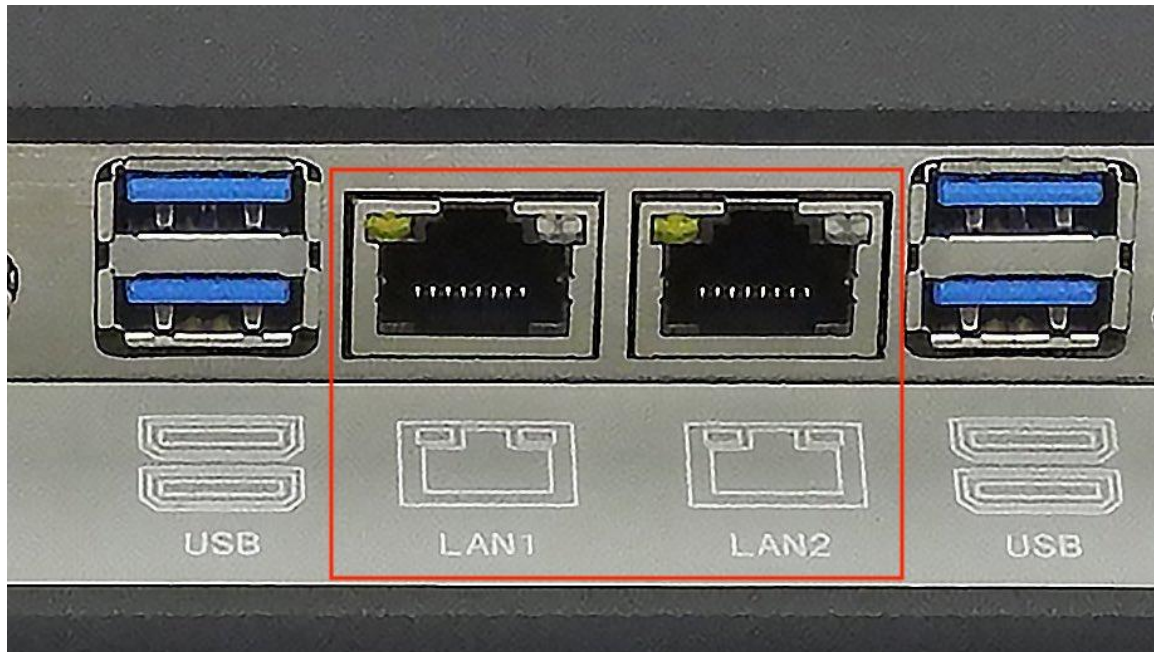

*2 x RJ45 GbE LAN Connectors*

### Note

Use CAT5 or better cables to achieve full data throughput over maximum distance defined by the 1000BASE-T standard (100m).

## HDMI Connector

The PPC-J6412-156-C Industrial Panel PC is equipped with 1 x **HDMI** connector. The HDMI connector allows connecting an additional (external) monitor. HDMI output resolution can be configured by the software.

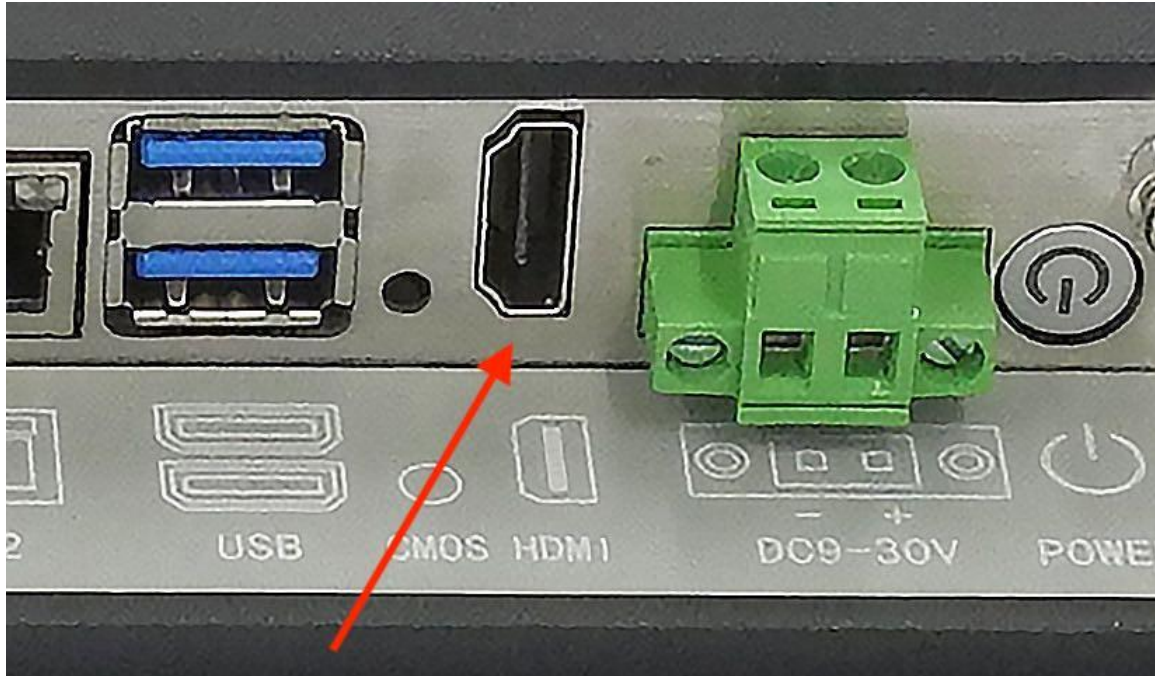

*HDMI Connector*

## Audio

The product has an audio jack to support microphone and line out, amplifier.

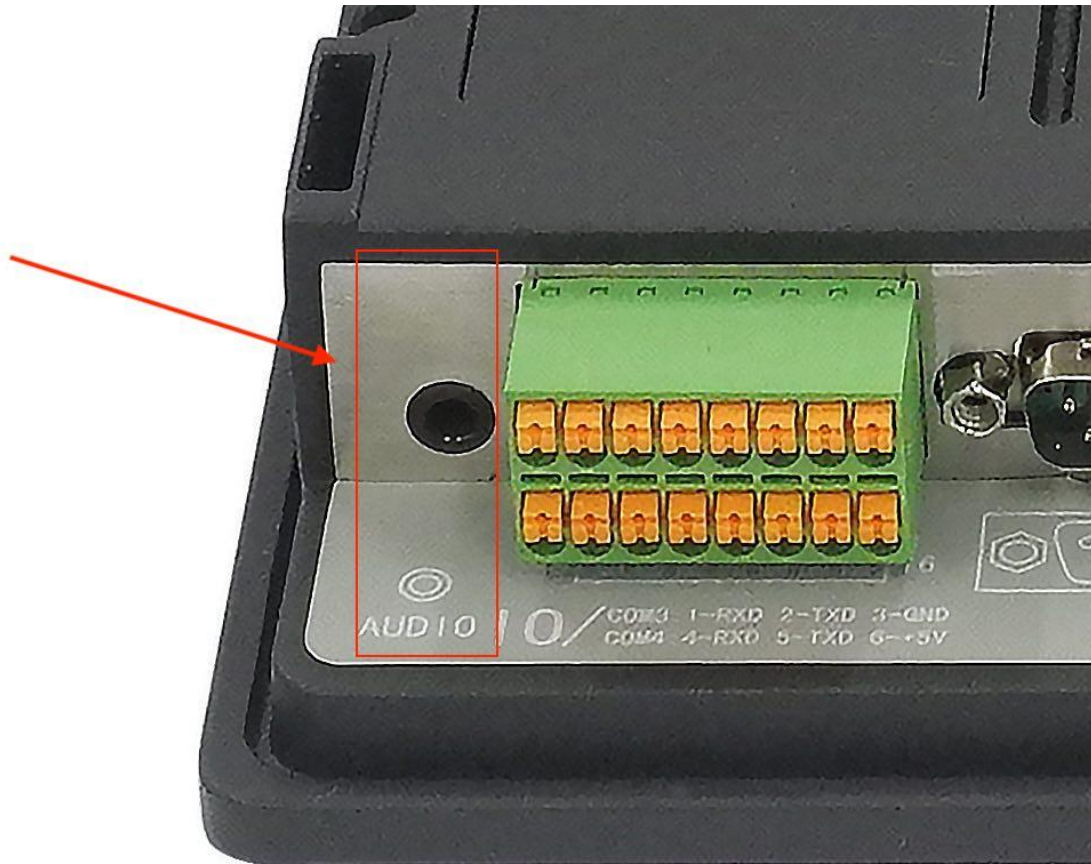

*Audio Jack*

## CMOS Button

There is a CMOS button you can use to reset the BIOS settings. While the PC is powered off, detach the power cable, you can press and hold the button for a few seconds to reset the BIOS settings.

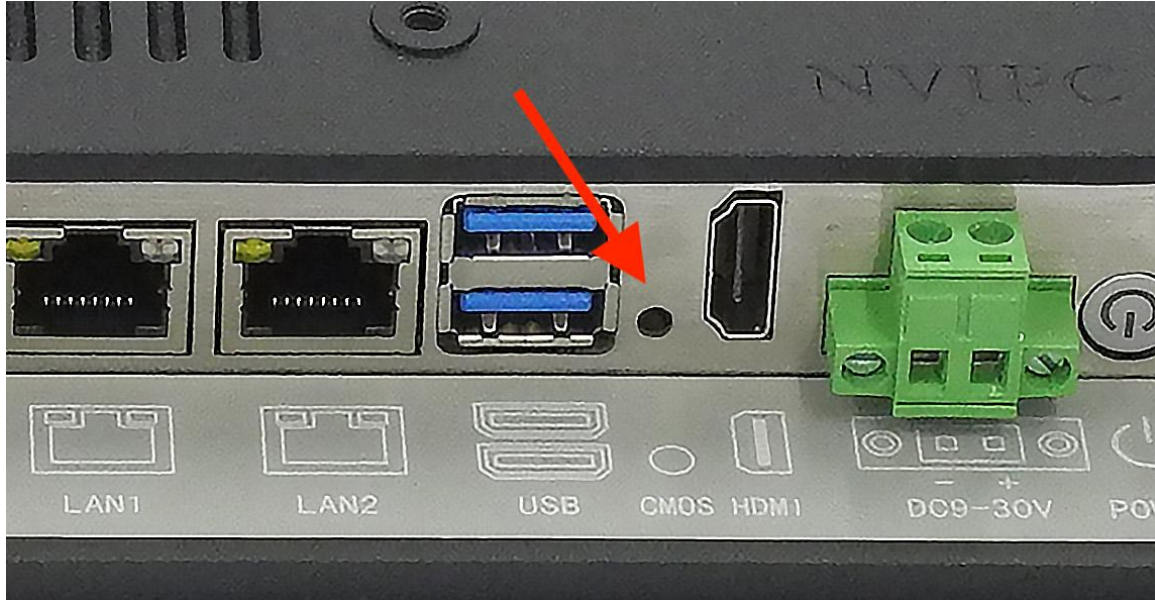

*CMOS Button*

## Mounting Procedure

The PPC-J6412-156-C Industrial Panel PC supports VESA 100 x 100 mounting pattern with 4 x M4 screws, enabling simplified installation onto any standard VESA mounting rack.

The PPC-J6412-156-C Industrial Panel PC supports panel mount, wall mount and desktop.

You can find detailed information about mounting in the [Mount IPC Guide](#).

## Mechanical Specifications

The outer mechanical dimensions of The PPC-J6412-156-C Industrial Panel PC are 422 × 271 × 52.5mm (W x L x H). Please refer to the technical drawing in the figure below for details related to the specific product measurements.

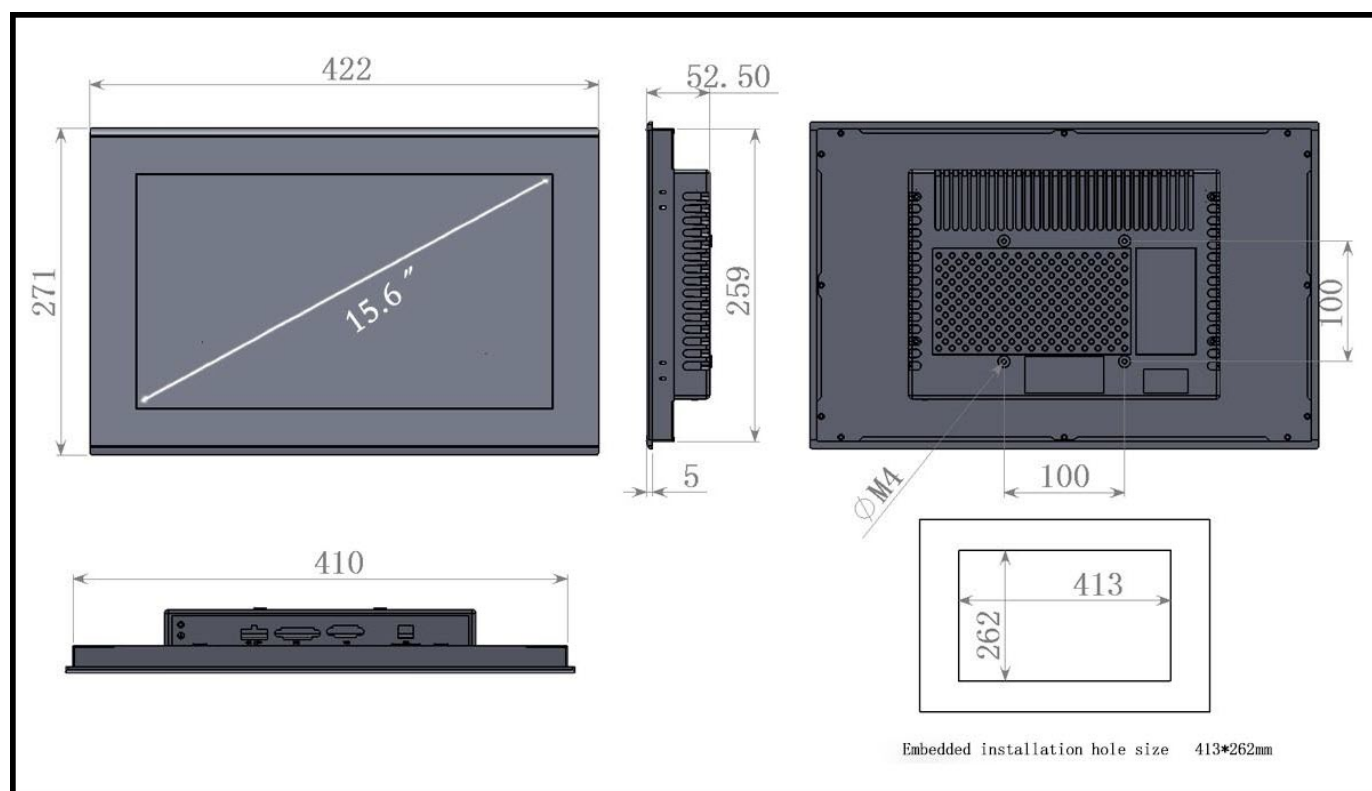

Figure 918: PPC-J6412-156-C Technical Drawing

## Disclaimer

This document is provided strictly for informational purposes. Its contents are subject to change without notice. Chipsee assumes no responsibility for any errors that may occur in this document. Furthermore, Chipsee reserves the right to alter the hardware, software, and/or specifications set forth herein at any time without prior notice and undertakes no obligation to update the information contained in this document.

While every effort has been made to ensure the accuracy of the information contained herein, this document is not guaranteed to be error-free. Further, it does not offer any warranties or conditions, whether expressed orally or implied in law, including implied warranties and conditions of merchantability or fitness for a particular purpose. We specifically disclaim any liability with respect to this document, and no contractual obligations are formed either directly or indirectly by this document.

Despite our best efforts to maintain the accuracy of the information in this document, we assume no responsibility for errors or omissions, nor for damages resulting from the use of the information herein. Please note that Chipsee products are not authorized for use as critical components in life support devices or systems.

## Technical Support

If you encounter any difficulties or have questions related to this document, we encourage you to refer to our other documentation for potential solutions. If you cannot find the solution you're looking for, feel free to contact us. Please email Chipsee Technical Support at [support@chipsee.com](mailto:support@chipsee.com), providing all relevant information. We value your queries and suggestions and are committed to providing you with the assistance you require.